



# SUZHOU PORCELAIN POST INSULATORS

Customers satisfaction and good servies are the top goals that SPIW always pursues.



Name: Suzhou Porcelain Insulator Works CO.,LTD  
Address: No.20 Chunhui Road, Weiting District, SIP Suzhou  
Tel: 0512-62758258; 62758268; 65306046  
Fax: 0512-65204704  
Postcode: 215122  
<http://www.spiwcn.com>

SUZHOU PORCELAIN INSULATORS WORKS CO.LTD  
JIANGSU CHINA



**SUZHOU  
PORCELAIN  
INSULATOR WORKS**

Suzhou porcelain insulator works CO.LTD (SPIW) is located in Suzhou, China—a famous historic and cultural city of the world. With its predominant environment of economy, humanity and geography, Suzhou created advanced external conditions for the developing of SPIW. SPIW was first built by the end of 1930'. By the year 2006 SPIW had invested more than 30 million US dollars for setting up two new production bases separately in SIP and SND which cover 120,000 square meters. By the end of 2008 SPIW had reach more than 46 million US dollars of its total assets. SPIW has accumulated more than 70 years' porcelain insulators manufacturing technologies and experiences. Especially after the first-stage and second-stage reconstructions, with huge breakthrough in the areas of equipments and technologies, SPIW has developed as a large-scale, comprehensive porcelain insulator manufactory.

SPIW has a strong force of technology. The products can be manufactured according to standards of IEC, ANSI, BS, AS and DIN etc. SPIW has both wet process production lines and iso-static pressing production lines for Station Post Insulators and hollows. At the present stage, the annually capacity of SPIW can reach 300,000 tons of all kinds of insulators.

SPIW has passed the audit of ISO9001:2000 Quality System by DNV( Det Norske veritas). And it has obtained "Recommended Company Certificate of main equipment (materials) for 330kV-500kV transmission lines", and has been qualified by National Power Grid Company to participate the centralized biddings of 330kV over transmission line projects.

High quality, wide range of products and high working efficiency has won a lot of clients home and

abroad, SPIW exports products to North America, South America, EU, Australia, Southeast Asia, Africa etc.

Customers' satisfaction and good services are the top goals that SPIW always pursues.

Series products of SPIW:

- 550kN and below A.C. Disc Porcelain Insulators
- 550kN and below D.C. Disc Porcelain Insul
- 145kV and below Line Post Porcelain Insulators
- 11.5kV, 24kV, 40.5kV, 72.5kV, 126kV, 220kV, 330kV, 550kV and 1100kV High Voltage Station Post Insulators
- ±400kV~±800kV Outdoor D.C. Station Post Insulators
- SF<sub>6</sub> circuit breaker hollow insulators, GIS composite apparatus hollow insulators, mutual inductor hollow insulators, transformer hollow insulators etc
- 8kN, 12kN, 16kN Solid Core Porcelain Insulators for Electrified Railway
- Solid Core Porcelain Insulators for City Subway



**Manufacture Process and Equipments**



Ball Mill



Mixing



Filter Pressing



Sieving And Electric Magnetic Filtering



Vacuum Extruding



Clay



Isostatic Pressing



Dry Shapping



Forming And Shaping



Drying



Glazing



Firing



Ultra-sonic Inspection



Assembling



Test

# Contents

NO. Type or Basic Insulation Level	Page
IEC: The following station post insulators comply with the IEC Standard. The glaze colour of the insulators are brown, light gray , blue etc.	
1. Type BIL 95kV	1
2. Type BIL 125kV	1
3. Type BIL 150kV	2
4. Type BIL 170kV	2
5. Type BIL 200kV	3
6. Type BIL 250kV	4
7. Type BIL 325kV	5
8. Type BIL 450kV	6
9. Type BIL 550kV	7
10. Type BIL 650kV	8
11. Type BIL 750kV	10
12. Type BIL 950kV	11
13. Type BIL 1050kV	12
14. Type BIL 1175kV	13
15. Type BIL 1300kV	13
16. Type BIL 1425kV	14
17. Type BIL 1550kV	14
18. Type BIL 1675kV	15
19. Type BIL 1800kV	16
20. Type BIL 1950kV	16
21. Type BIL 2100kV	17
22. Type BIL 2250kV	17
23. Type BIL 2400kV	17
ANSI: The following station post insulators comply with the IEC Standard. The glaze colour of the insulators are brown, light gray , blue etc.	
24. 95kV	18
25. 110kV	18
26. 150kV	18
27. 200kV	18
28. 250kV	19
29. 350kV	19
30. 550kV	19
31. 650kV	20
32. 750kV	20
33. 900kV	21
34. 1050kV	21
35. 1300kV	21
36. 1470kV	21
37. 1550kV	22
38. 1800kV	22
39. 2050kV	22

## Type BIL 95kV

Basic Insulation Level(kV)	95			
IEC Post Insulator Designation	C4-95 II	C4-95 II	C6-95 II	C8-95 II
Cat. No.	34431	34431W	34432	34430H
Fig. No.	1	2	1	1
Creepage Distance (mm)	380	550	380	394
Failing Load	Bending (kN)	4	4	6
	Torsion (kN · m)	0.8	0.8	0.8
Main Dimensions	H (mm)	255	255	255
	φ D (mm)	142	184	142
Top	a1 (mm)	4-M12	4-M12	4-M12
	φ d1 (mm)	76	76	76
Bottom	a2 (mm)	4-M12	4-M12	4-M12
	φ d2 (mm)	76	76	76
Impulse Withstand Voltage (kV)	95	95	95	95
Wet Power Frequency Withstand Voltage(kV)	38	38	38	38
Net Weight, Each, Approx(kg.)	6.4	9	6.4	6.8

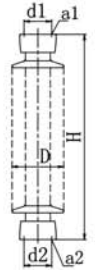

Fig.1

## Type BIL 125kV

Basic Insulation Level(kV)	125			
IEC Post Insulator Designation	C4-125III	C6-125III	C8-125 II	C10-125 II
Cat. No.	34629	34630	34439	34439G
Fig. No.	1	1	1	1
Creepage Distance (mm)	660	660	500	500
Failing Load	Bending (kN)	4	6	8
	Torsion (kN · m)	0.8	0.8	1.2
Main Dimensions	H (mm)	305	305	305
	φ D (mm)	160	160	155
Top	a1 (mm)	4-M12	4-M12	4-M12
	φ d1 (mm)	76	76	76
Bottom	a2 (mm)	4-M12	4-M12	4-M12
	φ d2 (mm)	76	76	76
Impulse Withstand Voltage (kV)	125	125	125	125
Wet Power Frequency Withstand Voltage(kV)	50	50	50	50
Net Weight,Each,Approx(kg.)	8.3	8.6	8.1	8.5

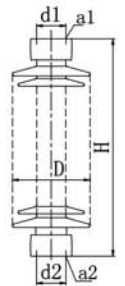

Fig.2

**IEC 60273**

**IEC 60273**

**Type BIL 150kV**

Basic Insulation Level(kV)		150				
IEC Post Insulator Designation		C4-150 II	C4-150III	C6-150 II	C8-150 II	C10-150 II
Cat. No.		34729	34470	34730	34619G	34623
Fig. No.		1	1	1	1	1
Creepage Distance (mm)		660	810	660	660	660
Failing Load	Bending (kN)	4	4	6	8	10
	Torsion (kN · m)	1	1	1.2	1.5	1.8
Main Dimensions	H (mm)	355	355	355	355	355
	φ D (mm)	160	160	160	195	164
Top	a1 (mm)	4-M12	4-M12	4-M12	4-M12	4-M12
	φ d1 (mm)	76	76	76	76	76
Bottom	a2 (mm)	4-M12	4-M12	4-M12	4-M12	4-M12
	φ d2 (mm)	76	76	76	76	76
Impulse Withstand Voltage (kV)		150	150	150	150	150
Wet Power Frequency Withstand Voltage(kV)		50	50	50	50	50
Net Weight,Each,Approx(kg.)		9.5	9.8	10.0	10.5	11.8

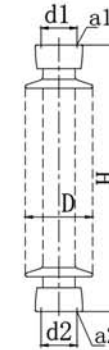

Fig.1

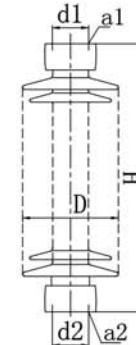

Fig.2

**Type BIL 170kV**

Basic Insulation Level(kV)		170					
IEC Post Insulator Designation		C4-170 II	C4-170IV	C6-170 II	C6-170IV	C8-170III	C10-170III
Cat. No.		34732	34708	34733	34708G	34658	34735
Fig. No.		1	2	1	2	2	1
Creepage Distance (mm)		900	1250	900	1250	1080	1010
Failing Load	Bending (kN)	4	4	6	6	8	10
	Torsion (kN · m)	1.2	1.2	1.5	1.5	2	2.5
Main Dimensions	H (mm)	445	445	445	445	445	445
	φ D (mm)	140	201	168	205	178	171
Top	a1 (mm)	4-M12	4-M12	4-M12	4-M12	4-M12	4-M12
	φ d1 (mm)	76	76	76	76	76	76
Bottom	a2 (mm)	4-M12	4-M12	4-M12	4-M12	4-M12	4-M12
	φ d2 (mm)	76	76	76	76	76	76
Impulse Withstand Voltage (kV)		170	170	170	170	170	170
Wet Power Frequency Withstand Voltage(kV)		70	70	70	70	70	70
Net Weight,Each,Approx(kg.)		11	14.6	11.5	15.1	15.6	20

**Type BIL 200kV**

Basic Insulation Level(kV)		200					
IEC Post Insulator Designation		C4-200 II	C6-200 II	C6-200IV	C8-200 II	C8-200IV	C10-200 II
Cat. No.		34736	34736G	34709	34737	34709G	34737G
Fig. No.		1	1	2	1	2	1
Creepage Distance (mm)		950	950	1320	950	1320	950
Failing Load	Bending (kN)	4	6	6	8	8	10
	Torsion (kN · m)	1.2	1.8	1.8	2	2	2.5
Main Dimensions	H (mm)	475	475	475	475	475	475
	φ D (mm)	154	154	212	160	215	168
Top	a1 (mm)	4-M12	4-M12	4-M12	4-M12	4-M12	4-M12
	φ d1 (mm)	76	76	76	76	76	76
Bottom	a2 (mm)	4-M12	4-M12	4-M12	4-M12	4-M12	4-M12
	φ d2 (mm)	76	76	76	76	76	76
Impulse Withstand Voltage (kV)		200	200	200	200	200	200
Wet Power Frequency Withstand Voltage(kV)		70	70	70	70	70	70
Net Weight,Each,Approx(kg.)		14.5	14.5	19.3	15.1	19.5	15.5

**IEC 60273**

**IEC 60273**

**Type BIL 250kV**

Basic Insulation Level(kV)		250					
IEC Post Insulator Designation		C4-250III	C4-250III	C4-250III	C6-250 II	C6-250III	C6-250III
Cat. No.		34741	34745L	34517	34742	34745E	34710
Fig. No.		2	2	2	1	2	2
Creepage Distance (mm)		1300	1325	1600	1200	1300	1320
Failing Load	Bending (kN)	4	4	4	6	6	6
	Torsion (kN · m)	1.8	1.8	1.8	2	2	2
Main Dimensions	H (mm)	560	560	560	560	560	560
	φ D (mm)	184	184	208	176	184	180
Top	a1 (mm)	4-M12	4-M16	4-M16	4-M12	4-M16	4-M16
	φ d1 (mm)	76	127	127	76	127	127
Bottom	a2 (mm)	4-M12	4-M16	4-M16	4-M12	4-M16	4-M16
	φ d2 (mm)	76	127	127	76	127	127
Impulse Withstand Voltage (kV)		250	250	250	250	250	250
Wet Power Frequency Withstand Voltage(kV)		95	95	95	95	95	95
Net Weight,Each,Approx(kg.)		19	18.5	23.6	18	18.5	18.7

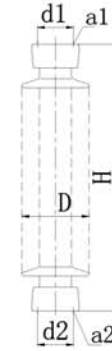

Fig.1

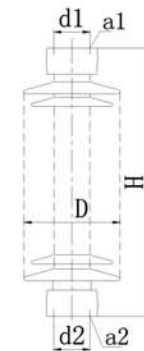

Fig.2

**Type BIL 250kV**

Basic Insulation Level(kV)		250					
IEC Post Insulator Designation		C6-250III	C6-250III	C8-250III	C8-250III	C10-250III	C12.5-250III
Cat. No.		34745H	34517A	34740H	34740E	34746B	34746G
Fig. No.		2	2	2	2	2	2
Creepage Distance (mm)		1450	1600	1320	1320	1300	1300
Failing Load	Bending (kN)	6	6	8	8	10	12.5
	Torsion(kN · m)	2	2	2.5	2.5	3	4
Main Dimensions	H (mm)	560	560	560	560	560	560
	φ D (mm)	194	208	195	195	200	200
Top	a1 (mm)	4-M16	4-M16	4-M12	4-M16	4-M16	4-M16
	φ d1 (mm)	127	127	76	127	127	127
Bottom	a2 (mm)	4-M16	4-M16	4-M12	4-M16	4-M16	4-M16
	φ d2 (mm)	127	127	76	127	127	127
Impulse Withstand Voltage (kV)		250	250	250	250	250	250
Wet Power Frequency Withstand Voltage(kV)		95	95	95	95	95	95
Net Weight,Each,Approx(kg.)		20	23.6	22.8	22.8	25.6	25.6

**Type BIL325kV**

Basic Insulation Level(kV)		325								
IEC Post Insulator Designation		C4-325 II	C4-325III	C4-325IV	C6-325 II	C6-325III	C6-325IV	C8-325III	C8-325IV	C10-325III
Cat. No.		34841	34506A	34725	34842	34506	34724	34845L	34724G	34845G
Fig. No.		1	2	2	1	2	2	1	2	1
Creepage Distance (mm)		1600	1823	2400	1600	1823	2250	1823	2250	1823
Failing Load	Bending (kN)	4	4	4	6	6	6	8	8	10
	Torsion (kN · m)	2	2	2	2.5	2.5	2.5	3	3	4
Main Dimensions	H (mm)	770	770	770	770	770	770	770	770	770
	φ D (mm)	190	190	209	190	190	208	205	213	210
Top	a1 (mm)	4-M16	4-M16	4-M16	4-M16	4-M16	4-M16	4-M16	4-M16	4-M16
	φ d1 (mm)	127	127	127	127	127	127	127	127	127
Bottom	a2 (mm)	4-M16	4-M16	4-M16	4-M16	4-M16	4-M16	4-M16	4-M16	4-M16
	φ d2 (mm)	127	127	127	127	127	127	127	127	127
Impulse Withstand Voltage (kV)		325	325	325	325	325	325	325	325	325
Wet Power Frequency Withstand Voltage(kV)		140	140	140	140	140	140	140	140	140
Net Weight,Each,Approx(kg.)		32	28	31.8	32	28	30.5	37.8	34	39

**IEC 60273**

**IEC 60273**

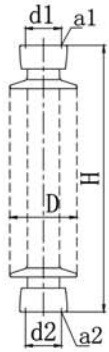

Fig. 1

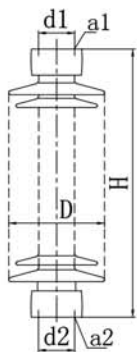

Fig. 2

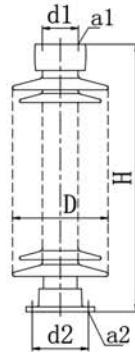

Fig. 3

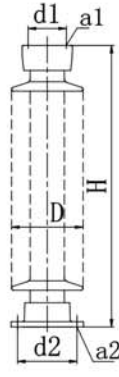

Fig. 4

**Type BIL450kV**

Basic Insulation Level(kV)	450								
IEC Post Insulator Designation	C4-450III	C6-450 I	C6-450 II	C6-450 II	C6-450III	C6-450III	C8-450 II	C8-450III	C8-450III
Cat. No.	34816	34895	34934	34507	34816G	34816A	34934G	34934W	34826
Fig. No.	2	1	3	2	2	3	3	3	2
Creepage Distance (mm)	3150	1850	2520	2500	3150	3150	2520	3150	3240
Failing Load	Bending (kN)	4	6	6	6	6	8	8	8
	Torsion (kN · m)	2.5	3.5	3.5	3.5	3.5	4	4	4
Main Dimensions	H (mm)	1020	1020	1020	1020	1020	1020	1020	1020
	φ D (mm)	235	178	210	210	235	235	210	235
Top	a1 (mm)	4-M16	4-M16	4-M16	4-M16	4-M16	4-M16	4-M16	4-M16
	φ d1 (mm)	127	127	127	127	127	127	127	127
Bottom	a2 (mm)	4-M16	4-M16	4-φ 18	4-M16	4-M16	4-φ 18	4-φ 18	4-M16
	φ d2 (mm)	127	127	200	127	127	178	200	127
Impulse Withstand Voltage (kV)	450	450	450	450	450	450	450	450	450
Wet Power Frequency Withstand Voltage(kV)	185	185	185	185	185	185	185	185	185
Net Weight,Each,Approx(kg.)	55	41.5	52	51	55	57	52	58	61.5

Suzhou Porcelain Insulator Works CO.,LTD.

**Type BIL550kV**

Basic Insulation Level(kV)	550												
IEC Post Insulator Designation	C4-550 II	C4-550III	C4-550III	C4-550IV	C4-550IV	C6-550 II	C6-550 II	C6-550 II	C6-550 III	C6-550 III	C6-550 III	C6-550 IV	C6-550 IV
Cat. No.	34508	34950A	34931	34951B	34953	34956D	34508A	34508E	34954E	34954D	34514	34994D	34969
Fig. No.	4	2	2	2	2	2	1	4	3	2	3	2	3
Creepage Distance (mm)	2600	3150	3300	3906	4500	2520	2600	2600	3150	3150	3150	3906	3906
Failing Load	Bending (kN)	4	4	4	4	4	6	6	6	6	6	6	6
	Torsion (kN · m)	3	3	3	3	3	4	4	4	4	4	4	4
Main Dimensions	H (mm)	1220	1220	1220	1220	1220	1220	1220	1220	1220	1220	1220	1220
	φ D (mm)	192	218	215	225	266	202	192	192	225	225	215	240
Top	a1 (mm)	4-M16	4-M16	4-M16	4-M16	4-M16	4-M16	4-M16	4-M16	4-M16	4-M16	4-M16	4-M16
	φ d1 (mm)	127	127	127	127	127	127	127	127	127	127	127	127
Bottom	a2 (mm)	4-φ 18	4-M16	4-M16	4-M16	4-M16	4-M16	4-M16	4-φ 18	4-φ 18	4-M16	4-φ 18	4-M16
	φ d2 (mm)	200	127	127	127	127	127	127	200	200	127	200	127
Impulse Withstand Voltage (kV)	550	550	550	550	550	550	550	550	550	550	550	550	550
Wet Power Frequency Withstand Voltage(kV)	230	230	230	230	230	230	230	230	230	230	230	230	230
Net Weight,Each,Approx(kg.)	54	59	56	65	80	52	53	54	64	63	59.5	72	75.5

**Type BIL 550kV**

Basic Insulation Level(kV)	550															
IEC Post Insulator Designation	C8-550 II	C8-550 II	C8-550 II	C8-550 III	C8-550 III	C8-550 III	C8-550 III	C8-550 IV	C10-55 0 II	C10-550 III	C10-55 0 III	C10-550 III	C12-550 III	C12-550 III	C16-550 III	C16-550 IV
Cat. No.	34508G	34508B	34508D	34954L	34937	34921H	34901	34892	34932HF	34960A	34960B	34960G	34989H	34955H	34989G	34989G
Fig. No.	4	1	4	2	2	3	3	4	2	2	3	3	3	3	3	3
Creepage Distance (mm)	2600	2600	2600	3150	3350	3150	3906	2520	3075	3350	3350	3150	3906	3150	3906	3906
Failing Load	Bending (kN)	8	8	8	8	8	8	8	10	10	10	10	12.5	12.5	16	16
	Torsion (kN · m)	4	4	4	4	4	4	4	4	4	4	4	6	6	6	6
Main Dimensions	H (mm)	1220	1220	1220	1220	1220	1220	1220	1220	1220	1220	1220	1220	1220	1220	1220
	φ D (mm)	192	192	192	225	215	225	240	227	230	240	240	245	255	241	267
Top	a1 (mm)	4-M16	4-M16	4-M16	4-M16	4-M16	4-M16	4-M16	4-M16	4-M16	4-M16	4-M16	4-M16	4-M16	4-M16	4-M16
	φ d1 (mm)	127	127	127	127	127	127	127	127	127	127	127	127	127	127	127
Bottom	a2 (mm)	4-φ 18	4-M16	4-φ 18	4-M16	4-M16	4-φ 18	4-φ 18	4-φ 18	4-M16	4-M16	4-φ 18	8-φ 18	8-φ 18	8-φ 18	8-φ 18
	φ d2 (mm)	200	127	225	127	127	200	200	225	127	127	225	254	254	254	254
Impulse Withstand Voltage (kV)	550	550	550	550	550	550	550	550	550	550	550	550	550	550	550	550
Wet Power Frequency Withstand Voltage(kV)	230	230	230	230	230	230	230	230	230	230	230	230	230	230	230	230
Net Weight,Each,Approx(kg.)	54	53	54	63	60	63.5	72	64	74	68	70	73	92	82	110	110

Suzhou Porcelain Insulator Works CO.,LTD.

**IEC 60273**

**IEC 60273**

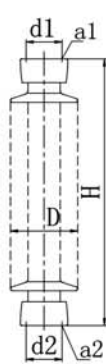

Fig.1

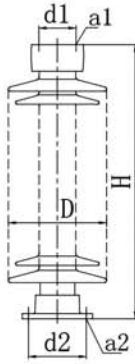

Fig.2

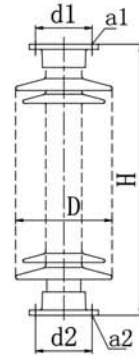

Fig.3

**Type BIL 650kV**

Basic Insulation Level(kV)	650														
IEC Post Insulator Designation	C4-650 II	C4-650 II	C4-650 III	C4-650 IV	C6-650 II	C6-650 III	C6-650 III	C6-650 III	C6-650 III	C6-650 III	C6-650 III	C6-650 III	C6-650 III	C6-650 III	C6-650 III
Cat. No.	34987D	34987E	34925	34992D	34987B	34925A	34502	34924	34925B	34504	34504A	34992	34992E	34992K	34992S
Fig. No.	2	1	2	1	2	1	1	2	2	1	2	1	2	3	2
Creepage Distance (mm)	3100	3100	3812	4568	3100	3812	3625	3625	3812	4495	4495	4495	4495	4495	4495
Failing Load	Bending (kN)	4	4	4	6	6	6	6	6	6	6	6	6	6	6
	Torsion (kN · m)	3	3	3	3	3	5	9.5	3	5	5	3	3	3	3
Main	H (mm)	1500	1500	1500	1500	1500	1500	1500	1500	1500	1500	1500	1500	1500	1500
Dimensions	φ D (mm)	197	197	225	233	197	225	215	220	225	235	235	233	233	233
	φ d1 (mm)	127	127	127	127	127	127	127	127	127	127	127	127	127	127
Top	a1 (mm)	4-M16	4-M16	4-M16	4-M16	4-M16	4-M16	4-M16	4-M16	4-M16	4-M16	4-M16	4-M16	4-M16	4-M16
	φ d1 (mm)	127	127	127	127	127	127	127	127	127	127	127	127	127	127
Bottom	a2 (mm)	4-φ18	4-M16	4-φ18	4-M16	4-φ18	4-M16	4-φ18	4-φ18	4-M16	4-φ18	4-M16	4-φ18	4-φ18	4-φ18
	φ d2 (mm)	200	127	200	127	200	127	200	200	127	200	127	225	225	200
Impulse Withstand Voltage (kV)	650	650	650	650	650	650	650	650	650	650	650	650	650	650	650
Wet Power Frequency Withstand Voltage(kV)	275	275	275	275	275	275	275	275	275	275	275	275	275	275	275
Net Weight,Each,Approx.(kg.)	67	66	79	88	68	79	73.2	81	79	83	84	88	90	93	90

Suzhou Porcelain Insulator Works CO.,LTD.

**Type BIL 650kV**

Basic Insulation Level(kV)	650						
IEC Post Insulator Designation	C8-650 II	C8-650 III	C8-650 III	C8-650 III	C8-650 IV	C8-650 IV	C8-650 IV
Cat. No.	34987P	34925G	34513	34513A	34992G	34512	34512A
Fig. No.	1	2	1	2	1	1	2
Creepage Distance (mm)	2900	3625	3625	3625	4495	4495	4495
Failing Load	Bending (kN)	8	8	8	8	8	8
	Torsion (kN · m)	4	4	5	4	4	4
Main	H (mm)	1500	1500	1500	1500	1500	1500
Dimensions	φ D (mm)	200	225	225	225	240	245
	a1 (mm)	4-M16	4-M16	4-M16	4-M16	4-M16	4-M16
Top	φ d1 (mm)	127	127	127	127	127	127
	a2 (mm)	4-M16	4-φ18	4-M16	4-φ18	4-M16	4-M16
Bottom	φ d2 (mm)	127	200	127	225	127	127
	φ d2 (mm)	127	200	127	225	127	225
Impulse Withstand Voltage (kV)	650	650	650	650	650	650	650
Wet Power Frequency Withstand Voltage(kV)	275	275	275	275	275	275	275
Net Weight,Each,Approx.(kg.)	68	80	76	78.5	96	85	87

**Type BIL 650kV**

Basic Insulation Level(kV)	650								
IEC Post Insulator Designation	C10-650 III	C10-650 III	C10-650 III	C10-650 IV	C10-650 IV	C12.5-650 III	C16-650 III	C16-650 IV	C20-650 IV
Cat. No.	34995	34926	34926B	34938	34938A	34995G	34513G	34923	34923G
Fig. No.	2	1	2	2	1	2	3	1	1
Creepage Distance (mm)	4250	3625	3625	4495	4495	4250	3625	4495	4495
Failing Load	Bending (kN)	10	10	10	10	10	12.5	16	20
	Torsion (kN · m)	4	4	4	4	4	6	6	6
Main	H (mm)	1500	1500	1500	1500	1500	1500	1500	1500
Dimensions	φ D (mm)	241	225	225	250	250	251	258	267
	a1 (mm)	4-M16	4-M16	4-M16	4-M16	4-M16	4-M16	4-φ18	4-M16
Top	φ d1 (mm)	127	127	127	127	127	127	225	127
	a2 (mm)	8-φ18	4-M16	8-φ18	8-φ18	4-M16	8-φ18	8-φ18	8-φ18
Bottom	φ d2 (mm)	254	127	254	254	127	254	275	275
	φ d2 (mm)	254	127	254	254	127	254	275	275
Impulse Withstand Voltage (kV)	650	650	650	650	650	650	650	650	650
Wet Power Frequency Withstand Voltage(kV)	275	275	275	275	275	275	275	275	275
Net Weight,Each,Approx.(kg.)	102	77	83	101	101	112	109	121	134

Suzhou Porcelain Insulator Works CO.,LTD.

**IEC 60273**

**Type BIL 750kV**

Basic Insulation Level(kV)	750										
IEC Post Insulator Designation	C4-750III	C4-750III	C4-750IV	C4-750IV	C6-750III	C6-750III	C6-750III	C6-750III	C6-750IV	C6-750IV	C6-750IV
Cat. No.	34893	34893B	34890D	34890A	34893A	34893D	34893K	34893G	34890B	34890	34893W
Fig. No.	2	1	2	2	2	1	3	2	2	1	1
Creepage Distance (mm)	4250	4250	5270	5270	4250	4250	4250	4250	5300	5300	6000
Failing Load	Bending (kN)	4	4	4	4	6	6	6	6	6	6
	Torsion (kN · m)	3	3	3	3	3	3	3	3	3	3
Main Dimensions	H (mm)	1700	1700	1700	1700	1700	1700	1700	1700	1700	1700
	φ D (mm)	208	208	234	234	208	208	208	234	234	245
Top	a1 (mm)	4-M16	4-M16	4-M16	4-M16	4-M16	4-φ18	4-M16	4-M16	4-M16	4-M16
	φ d1 (mm)	127	127	127	127	127	225	127	127	127	127
Bottom	a2 (mm)	4-φ18	4-M16	4-φ18	4-φ18	4-φ18	4-M16	4-φ18	4-φ18	4-M16	4-M16
	φ d2 (mm)	200	127	225	200	225	127	225	200	225	127
Impulse Withstand Voltage (kV)	750	750	750	750	750	750	750	750	750	750	750
Wet Power Frequency Withstand Voltage(kV)	325	325	325	325	325	325	325	325	325	325	325
Net Weight,Each,Approx(kg.)	89	88	105	104	91	90	92	91	105	103	108

**Type BIL 750kV**

Basic Insulation Level(kV)	750											
IEC Post Insulator Designation	C8-750III	C8-750III	C8-750III	C8-750IV	C8-750IV	C10-750III	C10-750III	C10-750IV	C10-750IV	C10-750IV	C12.5-750IV	C16-750IV
Cat. No.	34890G	34896	34896B	34887	34896W	34584	34584A	34896G	34583	34583A	34897	34897G
Fig. No.	1	2	3	2	2	2	3	2	2	3	2	2
Creepage Distance (mm)	4250	4250	4250	5270	5300	4250	4250	5300	5300	5300	5300	5300
Failing Load	Bending (kN)	8	8	8	8	10	10	10	10	10	12.5	16
	Torsion (kN · m)	4	4	4	4	4	4	4	4	4	6	6
Main Dimensions	H (mm)	1700	1700	1700	1700	1700	1700	1700	1700	1700	1700	1700
Dimensions	φ D (mm)	220	220	220	246	242	232	232	254	268	268	278
	φ d1 (mm)	127	127	225	127	127	127	225	127	127	225	127
Top	a1 (mm)	4-M16	4-M16	4-φ18	4-M16	4-M16	4-φ18	4-M16	4-M16	8-φ18	4-M16	4-M16
	φ d1 (mm)	127	127	225	127	127	127	225	127	127	225	127
Bottom	a2 (mm)	4-M16	4-φ18	4-φ18	4-φ18	4-φ18	8-φ18	8-φ18	8-φ18	8-φ18	8-φ18	8-φ18
	φ d2 (mm)	127	225	225	200	225	254	254	254	254	254	275
Impulse Withstand Voltage (kV)	750	750	750	750	750	750	750	750	750	750	750	750
Wet Power Frequency Withstand Voltage(kV)	325	325	325	325	325	325	325	325	325	325	325	325
Net Weight,Each,Approx(kg.)	100	103	106	110	117	105	108	129	119	122	133	150

**IEC 60273**

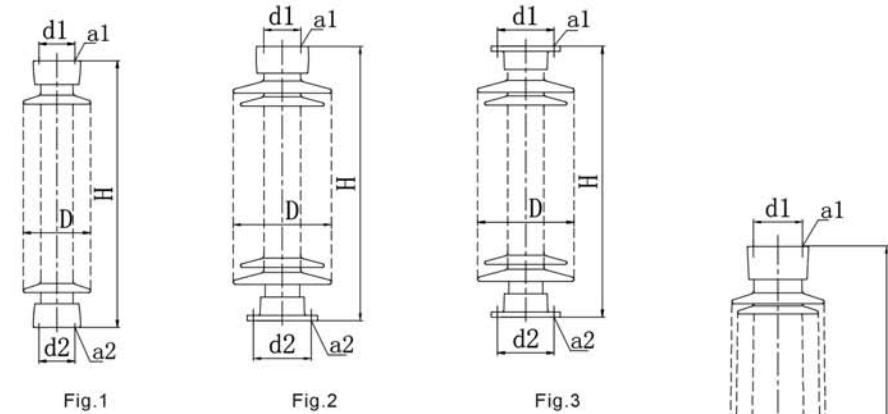

**Type BIL 950kV**

Basic Insulation Level(kV)	950					
IEC Post Insulator Designation	C4-950III	C6-950 II	C6-950III	C8-950III	C12.5-950III	
Cat. No.	36946	36908	36976	36974	36902	
Fig. No.	4	4	4	4	4	
Creepage Distance (mm)	6300	4900	6300	6300	6300	
Failing Load	Bending (kN)	4	4	6	8	12.5
	Torsion (kN · m)	3	3	3	4	6
Main Dimensions	H (mm)	2100	2100	2100	2100	2100
Dimensions	φ D (mm)	233	222	255	255	266
	φ d1 (mm)	127	127	127	127	127
Top	a1 (mm)	4-M16	4-M16	4-M16	4-M16	4-M16
	φ d1 (mm)	127	127	127	127	127
Bottom	a2 (mm)	4-φ18	4-φ18	4-φ18	8-φ18	8-φ18
	φ d2 (mm)	200	225	225	254	275
Impulse Withstand Voltage (kV)	950	950	950	950	950	
Wet Operation Impulse Withstand Voltage (kV)	750	750	750	750	750	
Wet Power Frequency Withstand Voltage(kV)	395	395	395	395	395	
Net Weight,Each,Approx(kg.)	136	122	145	148	173	
Composition	34976M	34934	34976B	34976B	34911	
	34886	34943A	34977B	34977A	34912	

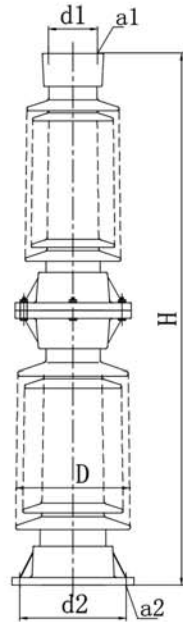

Fig.4



**IEC 60273**

**Type BIL 1050kV**

Basic Insulation Level(kV)	1050															
IEC Post Insulator Designation	C4-1050 II	C4-1050 III	C4-1050 III	C4-1050 III	C4-1050 IV	C6-1050 II	C6-1050 II	C6-1050 III	C6-1050 III	C6-1050 III	C6-1050 III	C6-1050 III	C6-1050 III	C6-1050 III	C6-1050 III	C6-1050 III
Cat. No.	36900B	36803	36970	36802	36970W	36900	36900A	36803A	36944	36944E	36804	36804B	36966	36966A		
Fig. No.	1	1	1	1	1	1	1	1	2	1	1	1	1	1		
Creepage Distance (mm)	4900	4900	6300	6300	7812	4900	4900	4900	6300	6300	6300	6300	7812	7812		
Failing Load	Bending (kN)	4	4	4	4	4	6	6	6	6	6	6	6	6		
	Torsion (kN·m)	3	3	3	3	3	3	3	3	3	4	4	4	4		
Main	H (mm)	2300	2300	2300	2300	2300	2300	2300	2300	2300	2300	2300	2300	2300		
	φ D (mm)	222	200	226	230	244	255	255	215	245	245	255	262	262		
Top	a1 (mm)	4-M16	4-M16	4-M16	4-M16	4-M16	4-M16	4-M16	4-M16	4-φ18	4-M16	4-M16	4-M16	4-M16		
	φ d1 (mm)	127	127	127	127	127	127	127	127	225	127	127	127	127		
Bottom	a2 (mm)	4-φ18	4-φ18	4-φ18	4-φ18	4-φ18	4-φ18	4-φ18	4-φ18	8-φ18	4-φ18	4-φ18	8-φ18	8-φ18		
	φ d2 (mm)	200	200	200	200	200	225	225	225	225	200	225	254			
Impulse Withstand Voltage (kV)	1050	1050	1050	1050	1050	1050	1050	1050	1050	1050	1050	1050	1050	1050		
Wet Operation Impulse Withstand Voltage (kV)	750	750	750	750	750	750	750	750	750	750	750	750	750	750		
Wet Power Frequency Withstand Voltage(kV)	460	460	460	460	460	460	460	460	460	460	460	460	460	460		
Net Weight,Each,Approx(kg.)	123	111	133	127	149	123	124	117	155	150	140	140	170	172		
Composition	34956A	34508	34961	34954E	34961W	34956A	34956A	34508E	34983	34985A	34514	34514	34980D	34980D		
	34943	34509	34963	34510	34963W	34943	34943A	34509A	34984B	34984A	34515	34515B	34981	34981A		

**Type BIL 1050kV**

Basic Insulation Level(kV)	1050																
IEC Post Insulator Designation	C8-1050 III	C8-1050 III	C8-1050 III	C8-1050 IV	C10-1050 III	C10-1050 III	C10-1050 III	C10-1050 IV	C10-1050 IV	C12-1050 III	C12-1050 III	C12-1050 III	C16-1050 III	C16-1050 III	C16-1050 III	C16-1050 III	
Cat. No.	36803G	36923A	36805	36941	36954A	36954B	36954	36954D	36954W	36956A	36956B	36954A	36956	36956W			
Fig. No.	1	1	1	1	2	1	2	1	2	1	2	1	2	2			
Creepage Distance (mm)	4900	6300	6300	7812	6300	6300	6300	7812	7812	6300	6300	7812	6300	7812			
Failing Load	Bending (kN)	8	8	8	8	10	10	10	10	12.5	12.5	12.5	16	16			
	Torsion (kN·m)	4	4	4	4	4	4	4	4	6	6	6	6	6			
Main	H (mm)	2300	2300	2300	2300	2300	2300	2300	2300	2300	2300	2300	2300	2300			
Dimensions	φ D (mm)	225	245	267	264	262	262	270	270	263	263	290	265	277			
	a1 (mm)	4-M16	4-M16	4-M16	4-M16	4-φ18	4-M16	4-φ18	4-M16	4-φ18	4-M16	4-φ18	4-M16	8-φ18	4-M16		
Top	φ d1 (mm)	127	127	127	127	225	127	225	127	225	127	225	127	254	127		
	a2 (mm)	8-φ18	8-φ18	8-φ18	8-φ18	8-φ18	8-φ18	8-φ18	8-φ18	8-φ18	8-φ18	8-φ18	8-φ18	8-φ18	8-φ18		
Bottom	φ d2 (mm)	254	254	254	254	275	275	254	275	275	275	275	300	300			
	Impulse Withstand Voltage (kV)	1050	1050	1050	1050	1050	1050	1050	1050	1050	1050	1050	1050	1050			
Wet Operation Impulse Withstand Voltage (kV)	750	750	750	750	750	750	750	750	750	750	750	750	750	750			
Wet Power Frequency Withstand Voltage(kV)	460	460	460	460	460	460	460	460	460	460	460	460	460	460			
Net Weight,Each,Approx(kg.)	126	159	165	176	178	175	176	193	195	202	204	215	220	240			
Composition	34508D	34983	34514G	34980D	34973A	34973	34973A	34973D	34973W	34985P	34985A	34880	34986D	34877			
	34508G	34986A	34515G	34988D	34970A	34970A	34970G	34970D	34970W	34906	34906	34828	34986A	34987			

**IEC 60273**

**Type BIL 1175kV**

Basic Insulation Level(kV)	1175						
IEC Post Insulator Designation	C6-1175 III	C6-1175 III	C6-1175 III	C6-1175 III	C8-1175 III	C10-1175 III	C10-1175 III
Cat. No.	36928	36928K	36928E	36928G	36928P	36921	36921A
Fig. No.	1	2	1	2	1	1	2
Creepage Distance (mm)	7595	7595	7700	7812	8730	7500	7820
Failing Load	Bending (kN)	6	6	8	8	8	10
	Torsion (kN·m)	3	3	4	4	4	4
Main	H (mm)	2650	2650	2650	2650	2650	2650
Dimensions	φ D (mm)	245	245	262	262	270	263
	a1 (mm)	4-M16	4-φ18	4-M16	4-φ18	4-M16	4-φ18
Top	φ d1 (mm)	127	225	127	225	127	225
	a2 (mm)	8-φ18	8-φ18	8-φ18	8-φ18	8-φ18	8-φ18
Bottom	φ d2 (mm)	254	254	254	254	254	275
	Impulse Withstand Voltage (kV)	1175	1175	1175	1175	1175	1175
Wet Operation Impulse Withstand Voltage (kV)	850	850	850	850	850	850	850
Net Weight,Each,Approx(kg.)	181	182	205	207	218	218	220
Composition	34992E	34992K	34995M	34995W	34596A	34995B	34995W
	34986A	34986A	34970G	34970G	34970W	34906	34906A

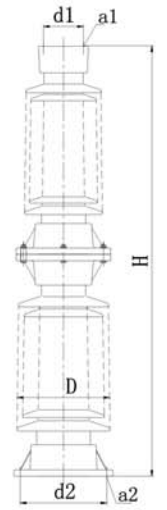

Fig.1

**Type BIL 1300kV**

Basic Insulation Level(kV)	1300						
IEC Post Insulator Designation	C6-1300 III	C6-1300 III	C6-1300 IV	C8-1300 III	C10-1300 III	C10-1300 III	C10-1300 III
Cat. No.	36989	36981	36981W	36987	36909	36909W	36981G
Fig. No.	1	1	1	1	1	1	1
Creepage Distance (mm)	7300	9050	11222	9050	7300	9050	11222
Failing Load	Bending (kN)	6	6	6	8	10	10
	Torsion (kN·m)	3	3	3	4	4	10
Main	H (mm)	2900	2900	2900	2900	2900	2900
Dimensions	φ D (mm)	237	267	289	295	260	298
	a1 (mm)	4-M16	4-M16	4-M16	4-M16	4-M16	4-M16
Top	φ d1 (mm)	127	127	127	127	127	127
	a2 (mm)	8-φ18	8-φ18	8-φ18	8-φ18	8-φ18	8-φ18
Bottom	φ d2 (mm)	275	275	275	271	275	275
	Impulse Withstand Voltage (kV)	1300	1300	1300	1300	1300	1300
Wet Operation Impulse Withstand Voltage (kV)	950	950	950	950	950	950	950
Net Weight,Each,Approx(kg.)	189	214	245	230	212	241	284
Composition	34925G	34992S	34913	34913G	34926B	34915	34917
	34947	34947W	34914	34914G	34916	34916	34918

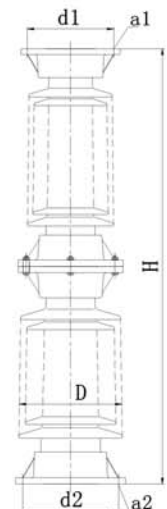

Fig.2

**IEC 60273**

**Type BIL 1425~1550kV**

Basic Insulation Level(kV)	1425				1550				
IEC Post Insulator Designation	C6-1425II	C6-1425III	C8-1425III	C10-1425II	C6-1550II	C6-1550III	C6-1550IV	C6-1550V	C6-1550VI
Cat. No.	36959	36979	36979G	36992	36969	36904	36915	36915A	36915B
Fig. No.	1	1	1	1	2	1	2	1	1
Creepage Distance (mm)	9050	10500	10500	9050	8400	10500	13020	13020	13020
Failing Load	Bending (kN)	6	6	8	10	6	6	6	6
	Torsion (kN · m)	3	3	4	4	3	3	3	3
Main	H (mm)	3150	3150	3150	3150	3350	3350	3350	3350
Dimensions	φ D (mm)	263	267	280	267	245	265	287	287
Top	a1 (mm)	4-M16	4-M16	4-M16	4-M16	4-φ 18	4-M16	4-M16	4-M16
	φ d1 (mm)	127	127	127	127	225	127	127	127
Bottom	a2 (mm)	8-φ 18	8-φ 18	8-φ 18	8-φ 18	8-φ 18	8-φ 18	8-φ 18	8-φ 18
	φ d2 (mm)	254	254	275	300	254	254	254	275
Impulse Withstand Voltage (kV)	1425	1425	1425	1425	1550	1550	1550	1550	1550
Wet Operation Impulse Withstand Voltage (kV)	950	950	950	950	1050	1050	1050	1050	1050
Net Weight,Each,Approx(kg.)	220	260	285	266	216	263	296	294	294
Composition	34890B	34967	34967G	34995	34893K	34964	34570	34568	34566
	34838	34968A	34968G	34908	34889	34974	34571	34569	34567

**Type BIL 1550kV**

Basic Insulation Level(kV)	1550						
IEC Post Insulator Designation	C8-1550III	C8-1550IV	C8-1550V	C10-1550II	C10-1550III	C10-1550IV	C125-1550II
Cat. No.	36905	36905W	36905H	36907B	36907A	36907W	36953A
Fig. No.	1	1	1	1	2	1	1
Creepage Distance (mm)	10500	13020	13750	11000	10500	13020	10500
Failing Load	Bending (kN)	8	8	8	10	10	10
	Torsion (kN · m)	4	4	4	4	4	4
Main	H (mm)	3350	3350	3350	3350	3350	3350
Dimensions	φ D (mm)	267	294	300	267	267	307
Top	a1 (mm)	4-M16	4-M16	4-M16	4-M16	4-φ 18	4-M16
	φ d1 (mm)	127	127	127	127	225	127
Bottom	a2 (mm)	8-φ 18	8-φ 18	8-φ 18	8-φ 18	8-φ 18	8-φ 18
	φ d2 (mm)	275	275	275	300	300	300
Impulse Withstand Voltage (kV)	1550	1550	1550	1550	1550	1550	1550
Wet Operation Impulse Withstand Voltage (kV)	1050	1050	1050	1050	1050	1050	1050
Net Weight,Each,Approx(kg.)	274	312	327	298	299	329	326
Composition	34964	34564	34562	34907B	34907A	34560	34897
	34965	34565	34563	34908B	34908	34561	34109S

Suzhou Porcelain Insulator Works CO.,LTD.

**IEC 60273**

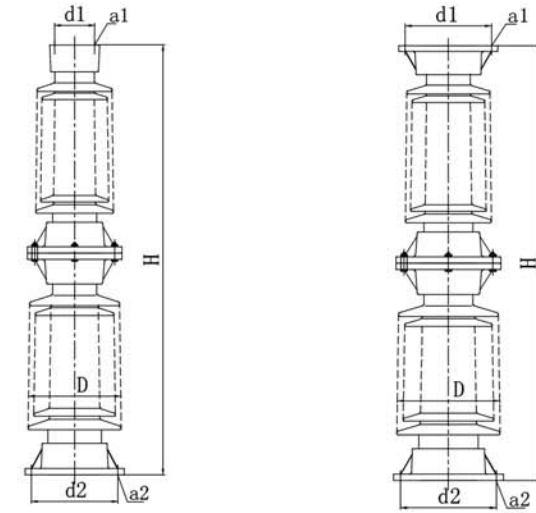

Fig.1

Fig.2

**Type BIL 1675kV**

Basic Insulation Level(kV)	1675						
IEC Post Insulator Designation	C6-1675III	C6-1675IV	C8-1675II	C8-1675IV	C8-1675V	C10-1675IV	C125-1675IV
Cat. No.	36934	36960	36929	36917	36917A	36961	36963
Fig. No.	2	1	1	1	2	2	2
Creepage Distance (mm)	10500	13750	11000	13750	13750	13750	13750
Failing Load	Bending (kN)	6	6	8	8	8	12.5
	Torsion (kN · m)	3	3	4	4	4	7
Main	H (mm)	3650	3650	3650	3650	3650	3650
Dimensions	φ D (mm)	273	287	280	302	302	315
Top	a1 (mm)	4-φ 18	4-M16	4-M16	4-M16	4-φ 18	4-φ 18
	φ d1 (mm)	225	127	127	127	225	225
Bottom	a2 (mm)	8-φ 18	8-φ 18	8-φ 18	8-φ 18	8-φ 18	8-φ 18
	φ d2 (mm)	275	275	300	300	300	325
Impulse Withstand Voltage (kV)	1675	1675	1675	1675	1675	1675	1675
Wet Operation Impulse Withstand Voltage (kV)	1050	1050	1050	1050	1050	1050	1050
Net Weight,Each,Approx(kg.)	283	322	292	372	373	390	467
Composition	34833	34587	34580	34578	34576	34574	34572
	34834	34582	34581	34579	34577	34575	34573

Suzhou Porcelain Insulator Works CO.,LTD.

**IEC 60273**

**Type BIL 1800kV**

Basic Insulation Level(kV)		1800							
IEC Post Insulator Designation		C6-1800II	C6-1800II	C6-1800III	C6-1800III	C8-1800II	C8-1800III	C10-1800II	C10-1800III
Cat. No.		38919A	38919	38920A	38920	38904	38905	38907	38908
Fig. No.		1	2	2	2	1	1	1	1
Creepage Distance (mm)		10500	10500	13750	13750	11000	13750	11000	13750
Failing Load	Bending (kN)	6	6	6	6	8	8	10	10
	Torsion (kN · m)	3	3	3	3	4	4	6	6
Main H (mm)		4000	4000	4000	4000	4000	4000	4000	4000
Dimensions $\phi$ D (mm)		269	269	290	290	298	298	298	298
Top	a1 (mm)	4-M16	4- $\phi$ 18	4- $\phi$ 18	4- $\phi$ 18	4-M16	4-M16	4-M16	4-M16
	$\phi$ d1 (mm)	127	225	225	225	127	127	127	127
Bottom	a2 (mm)	8- $\phi$ 18	8- $\phi$ 18	8- $\phi$ 18	8- $\phi$ 18	8- $\phi$ 18	8- $\phi$ 18	8- $\phi$ 18	8- $\phi$ 18
	$\phi$ d2 (mm)	275	275	275	300	300	300	300	300
Impulse Withstand Voltage (kV)		1800	1800	1800	1800	1800	1800	1800	1800
Wet Operation Impulse Withstand Voltage (kV)		1175	1175	1175	1175	1175	1175	1175	1175
Net Weight,Each,Approx.(kg.)		294	295	380	383	365	420	379	430
Composition		34992S	34992K	34913	34913	34995B	34917	34995B	34917
		34947	34947A	34914	34914	34928	34929	34916	34918
		34552	34552	34808A	34808	34808	34808	34808G	34808G

**Type BIL 1950kV**

Basic Insulation Level(kV)		1950							
IEC Post Insulator Designation		C6-1950III	C8-1950II	C8-1950III	C10-1950III	C10-1950III	C12.5-1950III	C16-1950III	C16-1950III
Cat. No.		38935	38921	38922A	38923	38924	38925A	38926	38926D
Fig. No.		1	2	1	1	2	2	2	2
Creepage Distance (mm)		13750	11350	13750	11350	13750	13750	13750	13750
Failing Load	Bending (kN)	6	8	8	10	10	12.5	16	16
	Torsion (kN · m)	3	4	4	4	4	6	6	6
Main H (mm)		4400	4400	4400	4400	4400	4400	4400	4400
Dimensions $\phi$ D (mm)		287	276	300	292	314	329	350	350
Top	a1 (mm)	4-M16	4- $\phi$ 18	4-M16	4-M16	4- $\phi$ 18	4- $\phi$ 18	4- $\phi$ 18	4- $\phi$ 18
	$\phi$ d1 (mm)	127	225	127	127	225	225	225	225
Bottom	a2 (mm)	8- $\phi$ 18	8- $\phi$ 18	8- $\phi$ 18	8- $\phi$ 18	8- $\phi$ 18	8- $\phi$ 18	8- $\phi$ 18	8- $\phi$ 18
	$\phi$ d2 (mm)	275	300	300	325	325	325	356	325
Impulse Withstand Voltage (kV)		1950	1950	1950	1950	1950	1950	1950	1950
Wet Operation Impulse Withstand Voltage (kV)		1300	1300	1300	1300	1300	1300	1300	1300
Net Weight,Each,Approx.(kg.)		365	350	442	381	500	529	575	576
Composition		34992S	34925H	34596	34926B	34596	34593	34590	34590
		34947W	34923A	34553	34923G	34597	34594	34591	34591
		34559	34599	34599	34599G	34598	34595A	34592	34592A

**IEC 60273**

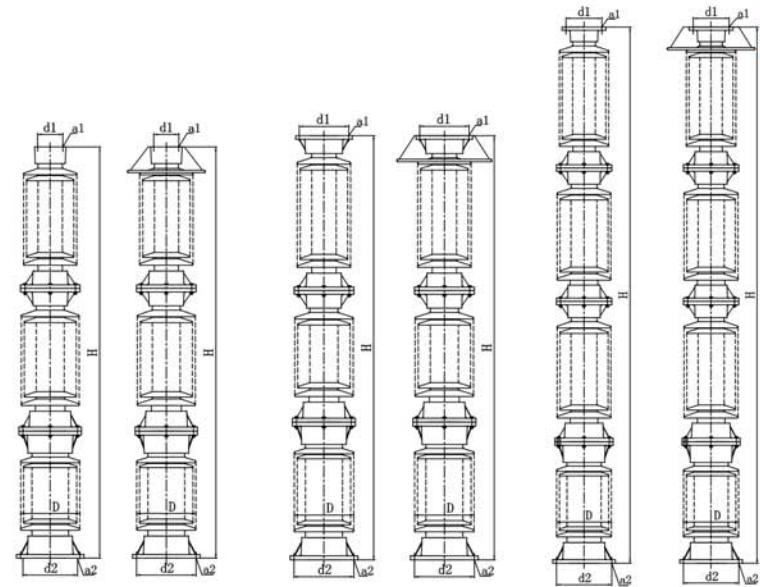

Fig.1

Fig.2

Fig.3

**Type BIL 2100~2400kV**

Basic Insulation Level(kV)		2100		2250	2400	
IEC Post Insulator Designation		C8-2100III	C10-2100III	C16-2100IV	C8-2400III	C10-2400III
Cat. No.		38927	38928	38926W	38930	38906
Fig. No.		2	2	2	3	3
Creepage Distance (mm)		14500	14500	17060	15000	17050
Failing Load	Bending (kN)	8	10	16	8	10
	Torsion (kN · m)	4	4	10	4	6
Main H (mm)		4700	4700	4700	5000	5300
Dimensions $\phi$ D (mm)		300	315	364	305	310
Top	a1 (mm)	4- $\phi$ 18	4- $\phi$ 18	8- $\phi$ 18	4- $\phi$ 18	4- $\phi$ 18
	$\phi$ d1 (mm)	225	225	254	225	225
Bottom	a2 (mm)	8- $\phi$ 18	8- $\phi$ 18	8- $\phi$ 18	8- $\phi$ 18	8- $\phi$ 18
	$\phi$ d2 (mm)	300	325	325	325	300
Impulse Withstand Voltage (kV)		2100	2100	2100	2250	2400
Wet Operation Impulse Withstand Voltage (kV)		1300	1300	1300	1425	1425
Net Weight,Each,Approx.(kg.)		428	473	692	450	548
Composition		34964	34907A	34127	34993G	34915
		34965	34908	34128	34989G	34929
		34589	34588	34129	34585	34805
		--	--	--	34586	34806

**ANSI C 29.9**

Basic Insulation Level(kV)	95		
Cat. No.	34429	34443	34443G
Ansi Technical Reference Number	TR202	TR222	
Fig.No.	1	1	1
Creepage Distance (in)	10 1/2	10 1/2	10 1/2
Cantilever Strength,Upright/Underhung(lb.)	2000	4000	8000
Tensile Strength(lb.)	7000	15000	28000
Torsion Strength,(In- lb.)	6000	12000	40000
Compression Strength(lb.)	10000	20000	40000
Impulse Flashover Voltage, Positive(kV)	105	105	105
Withstand Voltage	Low Frequency, Wet(kV)	30	30
	Impulse, (kV)	95	95
Radio-Influence Voltage Data	Test Voltage,Rms to Ground(kV)	5	5
	Maximum RIV at 1000 kHz(μ V)	50	50
Height-H (in)	7 1/2	10	10
Shed Diameter-D(in)	6 1/5	6 3/5	8 3/10
Top	Bolt Circle Diameter-a1,(in)	3	5
	(4) Tapped Holes-d1, (in)	1/2-13	5/8-11
Bottom	Bolt Circle Diameter-a2,(in)	3	5
	(4) Tapped Holes-d2, (in)	1/2-13	5/8-11
Net Weight,Each,Approx(lb.)	9.9	21.6	35.3

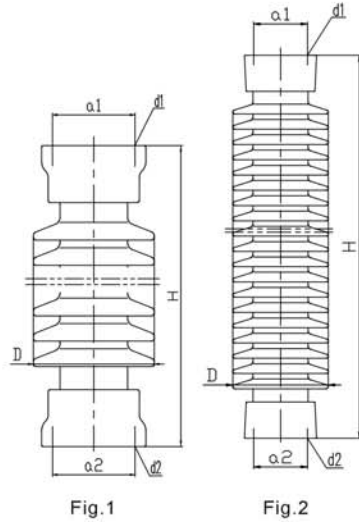

Fig. 1

Fig. 2

Basic Insulation Level(kV)	110			150			200		
Cat. No.	34430	34441	34441G	34620	34442	34442G	34731	34786	34786G
Ansi Technical Reference Number	TR205	TR225		TR208	TR227		TR210	TR231	
Fig.No.	1	1	1	1	1	1	1	1	1
Creepage Distance (in)	15 1/2	15 1/2	17	24	24	24	37	37	37
Cantilever Strength,Upright/Underhung(lb.)	2000	4000	8000	2000	4000	8000	2000	4000	8000
Tensile Strength(lb.)	8500	20000	28000	10000	20000	28000	12000	25000	28000
Torsion Strength,(In- lb.)	7000	14000	40000	8000	16000	40000	10000	20000	40000
Compression Strength(lb.)	10000	20000	40000	10000	20000	40000	15000	30000	60000
Impulse Flashover Voltage, Positive(kV)	125	125	125	170	170	170	225	225	225
Withstand Voltage	Low Frequency, Wet(kV)	45	45	45	60	60	80	80	80
	Impulse, (kV)	110	110	110	150	150	150	200	200
Radio-Influence Voltage Data	Test Voltage,Rms to Ground(kV)	10	10	10	15	15	22	22	22
	Maximum RIV at 1000 kHz(μ V)	50	50	50	100	100	100	100	100
Height-H (in)	10	12	12	14	15	15	18	20	20
Shed Diameter-D(in)	6 1/5	6 9/10	9 1/10	6 1/5	7 1/5	9 1/2	6 3/10	7 7/10	9 2/5
Top	Bolt Circle Diameter-a1,(in)	3	5	5	3	5	5	3	5
	(4) Tapped Holes-d1, (in)	1/2-13	5/8-11	5/8-11	1/2-13	5/8-11	5/8-11	1/2-13	5/8-11
Bottom	Bolt Circle Diameter-a2,(in)	3	5	5	3	5	5	3	5
	(4) Tapped Holes-d2, (in)	1/2-13	5/8-11	5/8-11	1/2-13	5/8-11	5/8-11	1/2-13	5/8-11
Net Weight,Each,Approx(lb.)	15.4	24.7	44.1	24.3	43.0	54.0	34.4	55.1	77.0

**ANSI C 29.9**

Basic Insulation Level(kV)	250			350		
Cat. No.	34740	34787	34787G	34846	34788	34800G
Ansi Technical Reference Number	TR214	TR267		TR216	TR278	
Fig.No.	1	1	1	1	1	1
Creepage Distance (in)	43	43	43	72	72	72
Cantilever Strength,Upright/Underhung(lb.)	2000	4000	8000	1500	3000	6000
Tensile Strength(lb.)	14000	25000	40000	16000	25000	40000
Torsion Strength,(In- lb.)	12000	20000	90000	15000	40000	90000
Compression Strength(lb.)	15000	60000	120000	25000	60000	120000
Impulse Flashover Voltage, Positive(kV)	280	280	280	390	390	390
Withstand Voltage	Low Frequency, Wet(kV)	100	100	145	145	145
	Impulse, (kV)	250	250	350	350	350
Radio-Influence Voltage Data	Test Voltage,Rms to Ground(kV)	30	30	44	44	44
	Maximum RIV at 1000 kHz(μ V)	200	200	200	200	200
Height-H (in)	22	24	25	30	30	32
Shed Diameter-D(in)	7 3/10	7 9/10	9 5/9	7 5/7	8 2/3	9 4/5
Top	Bolt Circle Diameter-a1,(in)	3	5	7	3	5
	(4) Tapped Holes-d1, (in)	1/2-13	5/8-11	3/4-10	1/2-13	5/8-11
Bottom	Bolt Circle Diameter-a2,(in)	3	5	7	3	5
	(4) Tapped Holes-d2, (in)	1/2-13	5/8-11	3/4-10	1/2-13	5/8-11
Net Weight,Each,Approx(lb.)	45.2	61.7	112.4	66.1	83.1	145

Basic Insulation Level(kV)	550					
Cat. No.	34940	34939	34940G	34940W	34939W	34940H
Ansi Technical Reference Number	TR286	TR287				
Fig.No.	2	2	2	2	2	2
Creepage Distance (in)	99	99	99	125	125	120
Cantilever Strength,Upright/Underhung(lb.)	1700	2600	5000	1700	2600	5000
Tensile Strength(lb.)	20000	25000	40000	20000	25000	40000
Torsion Strength,(In- lb.)	40000	90000	120000	40000	90000	120000
Compression Strength(lb.)	60000	75000	120000	60000	75000	120000
Impulse Flashover Voltage, Positive(kV)	610	610	610	610	610	610
Withstand Voltage	Low Frequency, Wet(kV)	230	230	230	230	230
	Impulse, (kV)	550	550	550	550	550
Radio-Influence Voltage Data	Test Voltage,Rms to Ground(kV)	73	73	73	73	73
	Maximum RIV at 1000 kHz(μ V)	200	200	200	200	200
Height-H (in)	45	45	45	45	45	45
Shed Diameter-D(in)	8 6/13	8 13/15	10	8 19/20	9 1/3	10 1/2
Top	Bolt Circle Diameter-a1,(in)	5	5	7	5	7
	(4) Tapped Holes-d1, (in)	5/8-11	5/8-11	3/4-10	5/8-11	5/8-11
Bottom	Bolt Circle Diameter-a2,(in)	5	5	7	5	7
	(4) Tapped Holes-d2, (in)	5/8-11	5/8-11	3/4-10	5/8-11	5/8-11
Net Weight,Each,Approx(lb.)	142.2	156.5	218.3	153.2	165.4	231.4

**ANSI C 29.9**

Basic Insulation Level(kV)		650					
Cat. No.		34941	34944	34941G	34941W	34944W	34941H
ANSI Technical Reference Number		TR288	TR289				
Fig.No.		1	1	1	1	1	1
Creepage Distance (in)		116	116	116	155	155	150
Cantilever Strength,Upright/Underhung(lb.)		1450	2200	4100	1450	2200	4100
Tensile Strength(lb.)		20000	25000	40000	20000	25000	40000
Torsion Strength,(In- lb.)		60000	90000	120000	60000	90000	120000
Compression Strength(lb.)		60000	75000	120000	60000	75000	120000
Impulse Flashover Voltage, Positive(kV)		710	710	710	710	710	710
Withstand Voltage	Low Frequency, Wet(kV)	275	275	275	275	275	275
	Impulse, (kV)	650	650	650	650	650	650
Radio-Influence Voltage Data	Test Voltage,Rms to Ground(kV)	88	88	88	88	88	88
	Maximum RIV at 1000 kHz(μ V)	200	200	200	200	200	200
Height-H (in)		54	54	54	54	54	54
Shed Diameter-D(in)		7 3/4	8 3/11	9 11/16	8 13/15	9 4/11	11
Top	Bolt Circle Diameter-a1,(in)	5	5	7	5	5	7
	(4) Tapped Holes-d1, (in)	5/8-11	5/8-11	3/4-10	5/8-11	5/8-11	3/4-10
Bottom	Bolt Circle Diameter-a2,(in)	5	5	7	5	5	7
	(4) Tapped Holes-d2, (in)	5/8-11	5/8-11	3/4-10	5/8-11	5/8-11	3/4-10
Net Weight,Each,Approx(lb.)		147.7	169.3	238.1	175.3	199.1	290.3

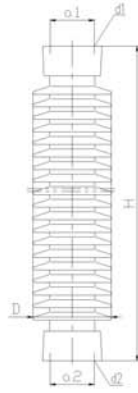

Fig. 1

Basic Insulation Level(kV)		750					
Cat. No.		34948	34949	34948G	34948W	34949W	34948H
ANSI Technical Reference Number		TR291	TR295				
Fig.No.		1	1	1	1	1	1
Creepage Distance (in)		132	132	132	180	180	180
Cantilever Strength,Upright/Underhung(lb.)		1200	1850	3500	1200	1850	3500
Tensile Strength(lb.)		20000	25000	40000	20000	25000	40000
Torsion Strength,(In- lb.)		40000	90000	120000	40000	90000	120000
Compression Strength(lb.)		60000	75000	120000	60000	75000	120000
Impulse Flashover Voltage, Positive(kV)		810	810	810	810	810	810
Withstand Voltage	Low Frequency, Wet(kV)	315	315	315	315	315	315
	Impulse, (kV)	750	750	750	750	750	750
Radio-Influence Voltage Data	Test Voltage,Rms to Ground(kV)	103	103	103	103	103	103
	Maximum RIV at 1000 kHz(μ V)	500	500	500	500	500	500
Height-H (in)		62	62	62	62	62	62
Shed Diameter-D(in)		7 5/9	7 7/8	9 2/15	8 13/15	9 1/6	10 3/7
Top	Bolt Circle Diameter-a1,(in)	5	5	7	5	5	7
	(4) Tapped Holes-d1, (in)	5/8-11	5/8-11	3/4-10	5/8-11	5/8-11	3/4-10
Bottom	Bolt Circle Diameter-a2,(in)	5	5	7	5	5	7
	(4) Tapped Holes-d2, (in)	5/8-11	5/8-11	3/4-10	5/8-11	5/8-11	3/4-10
Net Weight,Each,Approx(lb.)		174.2	194.0	269.0	204.0	226.2	317.5

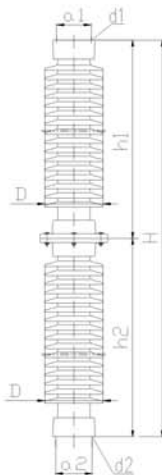

Fig. 2

**ANSI C 29.9**

Basic Insulation Level(kV)		900					1050		
Cat. No.		36993	36919A	36919G	36993A	36919W	36922	36990	36996
ANSI Technical Reference Number		TR304	TR308				TR312	TR316	TR362
Fig.No.		2	2	2	2	2	2	2	2
Creepage Distance (in)		165	165	165	192	192	198	198	198
Cantilever Strength,Upright/Underhung(lb.)		950	1450	2750	950	1450	800	1250	2300
Tensile Strength(lb.)		20000	25000	40000	20000	25000	20000	25000	40000
Torsion Strength,(In- lb.)		40000	90000	120000	40000	90000	40000	90000	120000
Compression Strength(lb.)		60000	75000	120000	60000	75000	60000	75000	100000
Impulse Flashover Voltage, Positive(kV)		1010	1010	1010	1010	1010	1210	1210	1210
Withstand Voltage	Low Frequency, Wet(kV)	385	385	385	385	385	455	455	455
	Impulse, (kV)	900	900	900	900	900	1050	1050	1050
Radio-Influence Voltage Data	Test Voltage,Rms to Ground(kV)	146	146	146	146	146	146	146	146
	Maximum RIV at 1000 kHz(μ V)	500	500	500	500	500	500	500	500
Height-H (in)		80	80	80	80	80	92	92	92
Height-h1 (in)		40	40	40	40	40	46	46	46
Height-h2 (in)		40	40	40	40	40	46	46	46
Shed Diameter-D1(in)		7 5/6	8 3/7	9 2/5	8 7/15	9 1/4	7 5/9	8 2/11	10
Shed Diameter-D2(in)		7 5/6	8 3/7	9 2/5	8 7/15	9 1/4	7 5/9	8 2/11	10
Top	Bolt Circle Diameter-a1,(in)	5	5	7	5	5	5	5	7
	(4) Tapped Holes-d1, (in)	5/8-11	5/8-11	3/4-10	5/8-11	5/8-11	5/8-11	5/8-11	3/4-10
Bottom	Bolt Circle Diameter-a2,(in)	5	5	7	5	5	5	5	7
	(4) Tapped Holes-d2, (in)	5/8-11	5/8-11	3/4-10	5/8-11	5/8-11	5/8-11	5/8-11	3/4-10
Net Weight,Each,Approx(lb.)		251.2	290.8	383.4	256.0	319.5	256.0	317.3	462.7

Basic Insulation Level(kV)		1300				1470			
Cat. No.		36994	36994G	36995G	36995	36997	36997G	36998	36998G
ANSI Technical Reference Number		TR324	TR367	TR368	TR369	TR330	TR371	TR373	TR372
Fig.No.		2	2	2	2	2	2	2	2
Creepage Distance (in)		231	231	231	231	264	264	264	264
Cantilever Strength,Upright/Underhung(lb.)		1000	1450	2000	2050	900	1170	1750	1750
Tensile Strength(lb.)		25000	20000	40000	25000	25000	20000	20000	40000
Torsion Strength,(In- lb.)		90000	40000	120000	90000	90000	40000	40000	120000
Compression Strength(lb.)		75000	60000	100000	90000	75000	60000	60000	100000
Impulse Flashover Voltage, Positive(kV)		1410	1410	1410	1410	1610	1610	1610	1610
Withstand Voltage	Low Frequency, Wet(kV)	525	525	525	525	590	590	590	590
	Impulse, (kV)	1300	1300	1300	1300	1470	1470	1470	1470
Radio-Influence Voltage Data	Test Voltage,Rms to Ground(kV)	220	220	220	220	220	220	220	220
	Maximum RIV at 1000 kHz(μ V)	1000	1000	1000	1000	1000	1000	1000	1000
Height-H (in)		106	106	106	106	122	122	122	122
Height-h1 (in)		53	53	53	53	61	61	61	61
Height-h2 (in)		53	53	53	53	61	61	61	61
Shed Diameter-D1(in)		8 3/11	7 3/4	9 7/10	8 3/11	7 3/5	7 3/5	7 9/10	9 1/10
Shed Diameter-D2(in)		8 3/11	8 19/20	9 7/10	9 7/10	7 9/10	8 3/10	9 1/10	9 1/10
Top	Bolt Circle Diameter-a1,(in)	5	5	7	5	5	5	5	7
	(4) Tapped Holes-d1, (in)	5/8-11	5/8-11	3/4-10	5/8-11	5/8-11	5/8-11	5/8-11	3/4-10
Bottom	Bolt Circle Diameter-a2,(in)	5	7	7	7	5	7	7	7
	(4) Tapped Holes-d2, (in)	5/8-11	3/4-10	3/4-10	3/4-10	5/8-11	3/4-10	3/4-10	3/4-10
Net Weight,Each,Approx(lb.)		341.5	378.2	520.0	443.2	367.9	414.2	462.6	537.6

**ANSI C 29.9**

Basic Insulation Level(kV)	1550			1800			2050		
Cat. No.	36860	36861	36862	38918	38914	38915	38916	38917	
Ansi Technical Reference Number	1550SS	TR379	1550EHS	TR391					
Fig.No.	1	1	2	3	4	4	5	6	
Creepage Distance (in)	320	280	305	330	360	360	432	432	
Cantilever Strength,Upright/Underhung(lb.)	1000	1700	2500	1400	1750	2500	1200	2000	
Tensile Strength(lb.)	20000	20000	25000	20000	20000	25000	20000	20000	
Torsion Strength,(In- lb.)	60000	40000	60000	40000	60000	90000	60000	60000	
Compression Strength(lb.)	60000	60000	60000	60000	60000	90000	60000	60000	
Impulse Flashover Voltage, Positive(kV)	1710	1710	1710	2000	2000	2000	2370	2370	
Withstand Voltage	Low Frequency, Wet(kV)	620	620	620	710	710	710	830	830
	Impulse, (kV)	1550	1550	1550	1800	1800	1800	2050	2050
Radio-Influence Voltage Data	Test Voltage,Rms to Ground (kV)	318	318	318	318	318	318	—	—
	Maximum RIV at 1000 kHz ( $\mu$ V)	2000	2000	2000	2000	2000	2000	—	—
Height—H (in)	128	128	128	152	152	152	182	185	
Height—h1 (in)	64	64	64	51	51	51	46	47	
Height—h2 (in)	64	64	64	50	50	50	45	46	
Height—h3 (in)	—	—	—	51	51	51	45	46	
Height—h4 (in)	—	—	—	—	—	—	46	46	
Shed Diameter—D1(in)	8 3/5	8 3/5	9 2/5	8 3/20	8 7/10	9 3/10	9 1/10	9 1/10	
Shed Diameter—D2(in)	9 1/5	9 1/10	9 4/5	8 19/25	9 9/10	10 7/10	9 1/10	10 3/10	
Shed Diameter—D3(in)	—	—	10 3/5	9 3/5	10 7/10	11 9/10	10 3/10	11 1/10	
Shed Diameter—D4(in)	—	—	—	—	—	—	11 1/10	11 9/10	
Top	Bolt Circle Diameter—a1,(in)	5	5	5	5	5	5	5	
	(4) Tapped Holes—d1, (in)	5/8-11	5/8-11	5/8-11	5/8-11	5/8-11	5/8-11	5/8-11	
Bottom	Bolt Circle Diameter—a2,(in)	7	7	14	7	14	7	14	
	(4) Tapped Holes—d2, (in)	3/4-10	3/4-10	$\Phi$ 0.81	3/4-10	$\Phi$ 0.81	$\Phi$ 0.88	3/4-10	$\Phi$ 0.88
Net Weight,Each,Approx.(lb.)	476.5	488.5	628.8	610	702.8	872.8	880.4	1059.3	

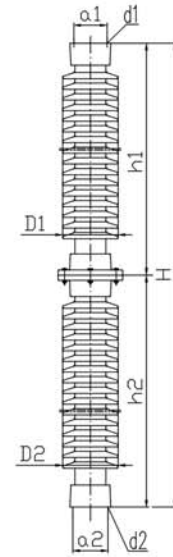

Fig. 1

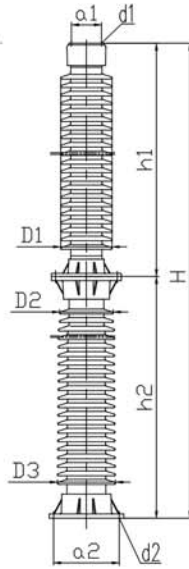

Fig. 2

**ANSI C 29.9**

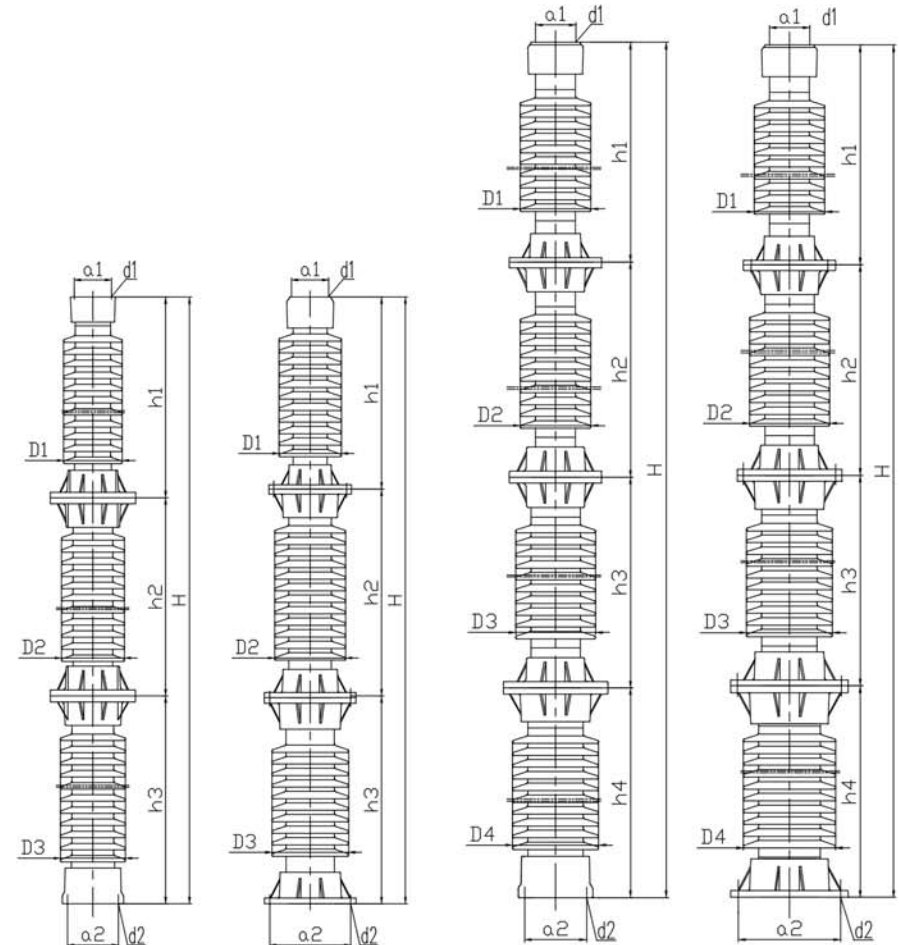

Fig. 3

Fig. 4

Fig. 5

Fig. 6